

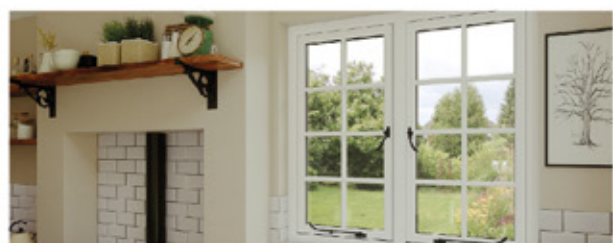

25 years of bespoke, high quality windows, doors and conservatories.



CONTENTS



"We have just had our full house done, and couldn't be happier! 3 door bi-fold on the back, 2 doors and full windows throughout. From enquiry to measure to fit, everyone involved has been fantastic."

- 04 THE LOCKWOOD WINDOW COMPANY
- 05 25 YEARS OF EXCELLENCE
- 06 OUR SHOWROOM

- 07 COMPOSITE DOORS
- 08 A SPECTRUM OF COLOUR
- 09 A TOUCH OF GLASS
- 10 ENERGY & SECURITY
- 11 - 15 THE ITALIA COLLECTION
- 16 ALNWICK, BERKELEY & STIRLING
- 17 EDINBURGH
- 18 LONDON
- 19 BEESTON
- 20 STAFFORD
- 21 LUDLOW
- 22 HARLECH
- 23 CONWAY
- 24 TENBY
- 25 FLINT
- 26 WINDSOR
- 27 NOTTINGHAM / THORNBURY
- 29 SIDE AND TOP LIGHTS
- 30 COMPOSITE FRENCH DOORS
- 31 STABLE DOORS
- 32 SHAPED COMPOSITE DOORS

- 34 BI-FOLD & SLIDING DOORS
- 35 PREMILINE PATIO / PVCU TILT & SLIDE
- 36 UPVC WINDOWS, DOORS & CONSERVATORIES
- 39 FLUSH SASH WINDOWS
- 40 UPVC WINDOWS
- 41 UPVC DOORS & STABLE DOORS

- 42 UPVC FRENCH DOORS
- 43 UPVC CONSERVATORIES
- 44 KOMMERLING
- 45 PILKINGTON KS GLASS
- 46 ENERGY & SECURITY

- 48 ACCESSORIES
- 49 - 50 DOOR KNOCKERS
- 51 DOOR HANDLES
- 52 THUMB TURNS / WINDOW HANDLES
- 53 DOOR NUMBERS, HINGES & LETTERPLATES
- 54 ESCUTCHEONS AND DOOR PULLS

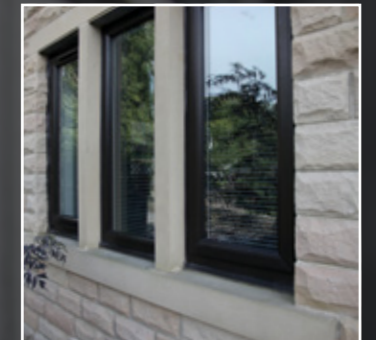

PLEASE NOTE THAT COLOURS AND FINISHES SHOWN MAY BE AFFECTED BY LIGHT CONDITIONS DURING THE PHOTOGRAPHY AND PRINT PROCESS.



25 YEARS



WELCOME TO THE LOCKWOOD WINDOW COMPANY

In 1998 we set up The Lockwood Window Company with the simple aim of offering the widest range of premium quality windows, doors and conservatories, matched by a professional, friendly approach.

We're still continuing to do this today, while providing even greater choice, including composite doors, aluminium bi-fold doors, along with the very latest technologies in energy saving glass, premium quality uPVC frames and state-of-the-art security.

By choosing Lockwood, you'll be working with a company that owns the whole process. We don't use subcontractors, we just use our team of experienced professionals who, in turn, have mentored our apprentices and other trainees. Some of these highly skilled people have been with us since the very start.

We manufacture bespoke frames and ensure that every installation is completed to the highest possible standards.

We install into domestic, new build developments and commercial buildings, and can offer a "supply only" service to both homeowners and businesses. Professional assurance for complete peace of mind. We're extremely proud to have achieved a position on the prestigious MWCIA Top 100 Registered company list.

We're also registered with FENSA, the industry standard for replacement windows, and all our products are covered by an insurance-backed guarantee.

Everything we manufacture is CE certified to comply with EU regulations.

25 YEARS OF EXCELLENCE

When we launched the Lockwood Window Company in 1998 we wanted to change the way people experienced buying windows and doors.

The hard-sales approach that was inherent within the industry wasn't the way we wanted to do business.

We wanted to give our customers a completely different experience, one based on understanding their needs, and working closely with them to help them get the look they want to achieve for their property.

We also wanted to focus on quality, workmanship and outstanding levels of customer service. This is because we know that any investment in the upkeep of your property is an important one.

Since 1998, our industry has seen enormous changes, as well as innovations too. Plus, the arrival of the internet around the time that we started has completely transformed the way all of us experience the world - even when it comes to new windows and doors.

So if you're considering enhancing your property, one thing that hasn't changed is our old-fashioned commitment to service, from experienced people who love doing what they do. With so many design options and a wide range of innovations, every new Lockwood window, door or conservatory starts with a conversation.

So why not come down and see us? In the meantime, head over to lockwoodwindows.co.uk

Richard Pogson

Richard Pogson
Lockwood Windows founder





COMPOSITE DOORS

The look of a solid timber door but with outstanding strength and durability

There are timber doors. There are foam filled doors. And there are Lockwood Window composite doors.

For unrivalled strength, security and durability, the composite doors made by us are designed to give you complete peace of mind that your door is a robust part of your property.

The doors we make feature:

- Solid timber construction
- Thermo plastic outer skins
- PVC outer frame reinforced with galvanised steel
- Astral S cylinder locks.

Cheaper foam-filled doors aren't as strong, or as durable. So, while they may be cheaper, they're by no means as strong, or as secure.

Style, frame, colour - the choice is yours.

There's a composite door for every style of property. Modern technology has resulted in the ability to create doors in a wide range of designs, with an extensive selection of glass options, including obscure glass.

Our French or stable doors are available in a range of door styles, although not all styles can be

adapted to French or door styles. We can explain this to you when you're making your selection. With our bespoke service we can also create shaped doors, and incorporate top lights and side lights into the frame ensuring your new door is probably the most secure on the market.



VISIT OUR SHOWROOM

We actively encourage our customers to come and visit our showroom at Lockwood Scar, Huddersfield, where we can show you our wide range of window and door products, including Kommerling uPVC frames, Pilkington KS Glass, as well as talk you through the energy rating system which is now a statutory framework for measuring the energy efficiency of your windows.

With so many styles, colours and designs to choose from, a member of our team will be happy to show you around. However, if you are planning to visit our showroom we would advise making an appointment to avoid disappointment during busier times, especially Saturdays.

Please call us on 01484 519667 to book.

You can see all the colours and finishes for yourself, and we can also show you the various accessories in a wide range of heritage and contemporary styles to complete the look you want for your home.

Opening Hours
 Mon - Thurs 8:00am - 5:00pm
 Fri 8:00am - 4:30pm
 Sat 9:00am - 12:00 noon



Our Construction

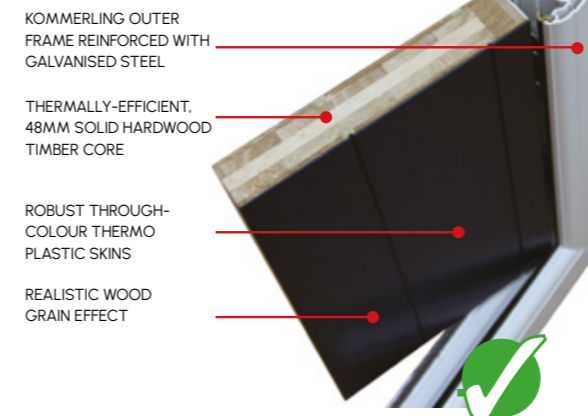

A Typical Foam Filled Construction

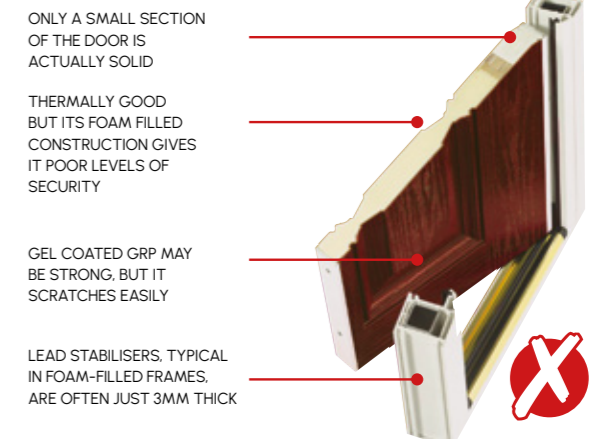

A SPECTRUM OF COLOUR

Whatever the age or architectural style of your property, we've a full spectrum of colours to choose from for your composite door. We have 5 standard colours and 15 premium colours available that can be chosen for any of our composite door styles. Do your front door your way.

STANDARD



BLACK RAL 9005 BLUE RAL 5011 GREEN RAL 6009 RUBY RED RAL 3003 WHITE RAL 9016

PREMIUM



ANTHRACITE GREY RAL 7016 CHARTWELL GREEN RAL 6021 NOT A PERFECT MATCH OR BS14C35 ICEPLANT GREEN) CREAM RAL 9001 DUCK EGG BLUE BRITISH STANDARD RANGE, 4800/5252 REF 20-C-33 FOILED WHITE RAL 9010



FRENCH GREY RAL 7001 GOLDEN OAK FOILED MATERIAL IRISH OAK FOILED MATERIAL MIDNIGHT GREY RAL 2303010 TWILIGHT GREY RAL 7000



PAINSWICK RAL 7038 PEACOCK BLUE BS381C103 ROSEWOOD FOILED MATERIAL SCHWARZBRAUN RAL 8022 TANGERINE RAL 2009



BUTTERCUP FOREST GREEN PISTACHIO TRUFFLE BROWN

*PLEASE NOTE THAT THE FOLLOWING SWATCHES ARE FOR ILLUSTRATIVE PURPOSES ONLY AND MAY VARY FROM THEIR APPEARANCE IN PERSON. WE ADVISE ALL OUR CUSTOMERS TO CHOOSE FROM ACTUAL SWATCHES SHOWN TO YOU IN OUR SHOWROOM.

A TOUCH OF GLASS

Front door. Side door. Back door. Make a brilliant first impression with every door. And because every home is unique, our extensive range of designs and finishes means your front door can be the style statement you want it to be - whether that's heritage, contemporary or retro with a modern twist.

BACKING GLASS (AVAILABLE IN A SELECTION OF OPACITY LEVELS)



ARCTIC AUTUMN EVERGLADE MINSTER WARWICK

GLASS DESIGNS

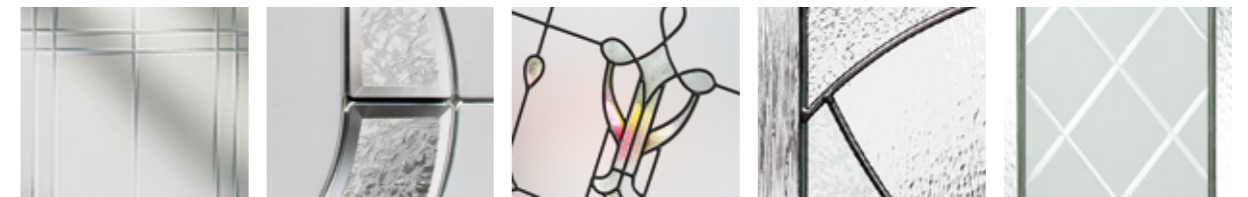

LINEAR MODENA PARK LANE BESPOKE ABSTRACT BRILLIANTE



DIAMOND (RED) DIAMOND (LEAD) ELEGANCE JEWEL QUAD (BLUE)

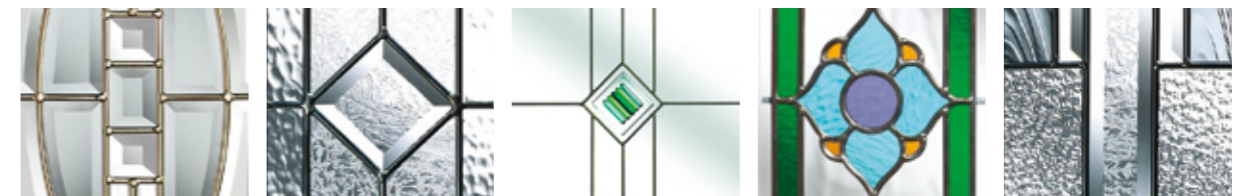

REFLECTIONS SIMPLICITY TRIO SQUARE (GREEN) DORCHESTER PRAIRIE



CALEDONIAN ROSE ZINC ART STAR MATRIX BLACK STAR POTOMAC

PLEASE NOTE THAT NOT ALL GLASS DESIGNS ARE AVAILABLE IN ALL DOOR STYLES DUE TO THE SIZE APERTURE OF SOME GLAZING SECTIONS. WE CAN EXPLAIN THIS WHEN YOU COME TO MAKE YOUR FINAL SELECTION.



ENERGY EFFICIENT DOORS & SECURITY

The world has changed in so many ways since we first established Lockwood Windows, and one of the biggest changes has been the way we value energy.

It's now an increasingly expensive household cost, which is why your windows and doors need to play a bigger part in keeping the heat in, the cold out, and your energy bills as low as possible.

The most energy efficient composite door

By choosing a Lockwood composite door you're investing in a premium quality product that will not only be an asset to your home, or business, but will play its part in reducing your carbon footprint.

Here's why:

- Timber used in all our doors is from sustainably managed forests
- Each door can be recycled at the end of its life
- Every door has a 5 chambers uPVC frame
- They also have lead-free skins and edgebanding
- They're manufactured in the UK to reduce transport mileage

You could say, all our doors are green!

Smart glass - Pilkington KS Glass

One of the biggest innovations since we set up business has been in glass technology, and the introduction of thermal energy ratings in 2010.

This means that the glass we now have to use to comply with Building Regulations Part L has to achieve high energy ratings.

This is why we now use energy efficient Pilkington KS Glass, a low emissivity coated glass which reflects heat back into the room whilst also letting in free heat from the sun. This is known as "passive solar gain".

Safe as houses

A property is burgled every minute in the UK, which is why a key part of your investment in doors and windows is to provide you with maximum security.

With their 48mm thick solid timber core, our composite doors are equipped with Astral S, a pick-resistant, multi-point locking system, and a reinforced door frame, making them the strongest and most secure option available on the residential door market.

We only use the highest standard of cylinder in our locking systems - tested to BS EN 1303, the highest grade for security, proving the highest level of resistance against physical attack.

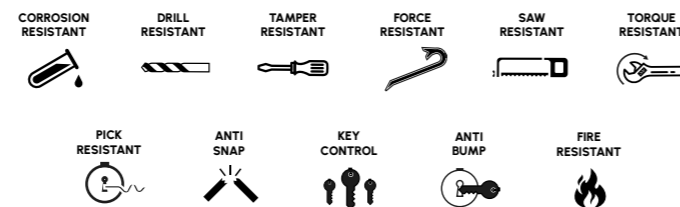

THE ITALIA COLLECTION

Inspired by the Italian passion for design, our Italia collection brings contemporary looks with understated style to your home. Crafted from the finest materials every composite door in our Italia range is simple and elegant with a touch of Italian chic.





All doors in our Italia collection can be made to bespoke requirements with a choice of glass and accessories. Visit our website to explore the full collection, and ways in which you can make your Italia door uniquely yours.

THE ITALIA COLLECTION

THE ITALIA COLLECTION

Magnifico! This really is the ultimate composite door. Outstanding quality, exceptional finish, unsurpassed attention to detail. Italian styling and perfection, in every sense.



ANCONA SOLID
IN DUCK EGG BLUE



AMALFI
IN RUBY RED

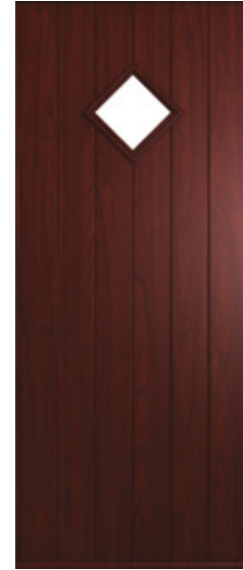

BOLOGNA
IN ROSEWOOD



BRESCIA
IN WHITE



MODENA
IN ANTHRACITE GREY



MONZA
IN FRENCH GREY



NAPLES
IN ANTHRACITE GREY



PARMA
IN PAINSWICK



GARDA
IN MIDNIGHT GREY



GENOA
IN GOLDEN OAK



MESSINA
IN BLACK



MILANO
IN CHARTWELL GREEN



PISA
IN BLACK



RIMINI
IN FOILED WHITE



ROMA
IN BLACK



SIENA
IN DUCK EGG BLUE

PLEASE NOTE ALL ITALIA RANGE ARE AVAILABLE WITH LEVER HANDLE

PLEASE NOTE ALL ITALIA RANGE ARE AVAILABLE WITH LEVER HANDLE

THE ITALIA COLLECTION

From luxury apartments to a period cottage, the 20 different designs in this collection means there's a high quality Italia composite front door for your home.

GLASS OPTIONS FOR TRADITIONAL RANGE

Make your Italia door reflect your personality and style with our extensive range of glass designs.*



SORRENTO
IN CREAM



TRIESTE
IN ANTHRACITE GREY



TURIN
IN CREAM



VENICE
IN BLUE

PLEASE NOTE ALL ITALIA RANGE ARE AVAILABLE WITH LEVER HANDLE

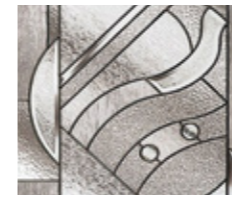

ABSTRACT



BRILLIANTE



BULLSEYE



CLARITY

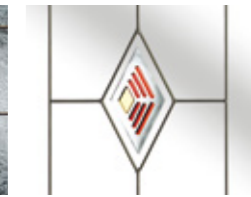

DIAMOND RED



ELEGANCE



ETCHED SQUARES

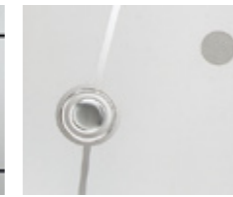

FLINT5 POTOMAC



FLINT5 REFLECTIONS



JEWEL



LINEAR

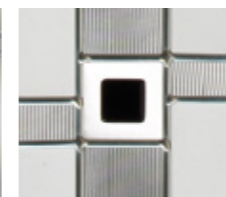

MODENA LEFT



PARK LANE



PRAIRIE

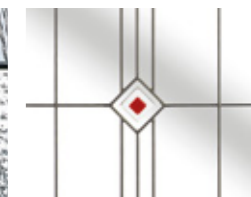

QUAD RED



ROYALE



SIMPLICITY

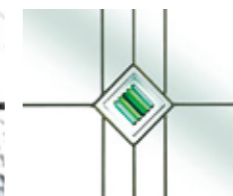

TRIO SQUARE GREEN

*PLEASE NOTE: NOT ALL GLAZING DESIGNS ARE SUITABLE FOR ALL DOORS IN THE RANGE. PLEASE ASK FOR MORE INFORMATION.



PAINSWICK STIRLING DOOR WITH FLEMISH GLASS



STIRLING DOOR IN PEACOCK BLUE WITH DORCHESTER GLASS.



ALNWICK, BERKELEY & STIRLING

Drawing on our rich architectural heritage, this charming collection of doors takes its design cues from key eras of our past. With its large-glazed panel to allow an abundance of natural light, the Alnwick Art Deco styling is the perfect choice if you're looking for that distinctive 30s style. Meanwhile, the Berkeley draws its influences from the Georgian era and comes in two styles, as does the Stirling whose typical Georgian styling makes it the perfect choice for either period cottages or modern homes.

EDINBURGH

If you're looking for an alternative to classic Victorian styles, the four-panel Edinburgh is a distinctive design in two different options - either offering complete privacy, or enabling an abundance of natural light to flood into your home.



ALNWICK
IN RUBY RED



BERKELEY SOLID
IN FRENCH GREY



STIRLING
IN CHARTWELL GREEN



ALNWICK
IN PEACOCK BLUE



BERKELEY
IN GREEN



STIRLING
IN ANTHRACITE GREY



EDINBURGH
SOLID
IN CHARTWELL GREEN



EDINBURGH
SOLID
IN DUCK EGG BLUE



EDINBURGH
IN PAINSWICK GREEN
WITH GLAZED GLASS



EDINBURGH
IN ROSEWOOD WITH
GLAZED GLASS



BEESTON COMPOSITE DOOR IN WHITE WITH BESPOKE GLASS.

LONDON

Get the Edwardian London look with a design that draws inspiration from doors typical of the period at the turn of the 20th century in our capital city. The arched glazed panel gives the London its handsome good looks.



LONDON IN PAINSWICK
 LONDON IN FRENCH GREY
 LONDON IN RUBY RED
 LONDON IN SCHWARZBRAUN

BEESTON

The Beeston is a traditional classic composite door that can be personalised with side panels and a wide range of glazing options. It's also hugely popular as a stable door.



ELEGANCE



BRILLIANTE GLASS



BEESTON 1 IN BLACK WITH BRILLIANTE GLASS
 BEESTON 1 IN BLUE
 BEESTON 1 IN RUBY RED WITH JEWEL GLASS



BEESTON COMPOSITE STABLE DOOR IN GREEN WITH PRAIRIE GLASS



STAFFORD

With its large, arched glazed panel the Stafford is a stylish front door with a difference, and one you can tailor to your personal taste with a range of different glazing designs.

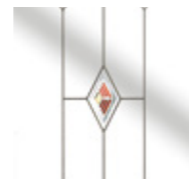

DIAMOND RED

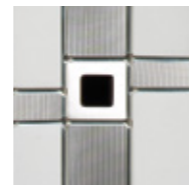

MODENA



ELEGANCE



STAFFORD 1
IN GREEN WITH
CTL 271 GLASS



STAFFORD 1
IN RUBY RED WITH
DIAMOND LEAD GLASS

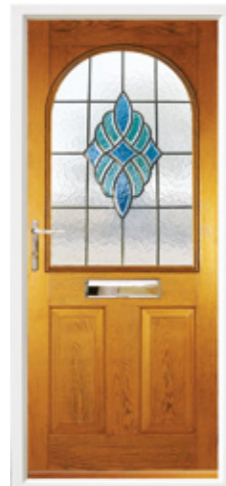

STAFFORD 1
IN OAK WITH
CTB 71 GLASS

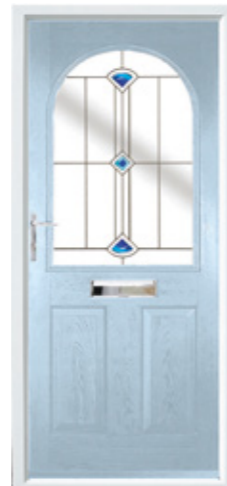

STAFFORD 1
IN DUCK EGG BLUE WITH
QUAD BLUE GLASS

LUDLOW

A modern classic, the Ludlow is one of our most popular door designs and makes a real style statement either as a solid door or with glazed panels. Works well with both strong colours or wood effect, such as Irish Oak. For glazed insert panel options, see P9.



LUDLOW 2
IN ROSEWOOD WITH
BRILLIANTE GLASS



LUDLOW 2
IN BLACK WITH
CFT 2.2 GLASS



LUDLOW 2
IN CHARTWELL GREEN
WITH CTB 19.2 GLASS



LUDLOW 2
IN DUCK EGG BLUE
WITH CTB 8.2 GLASS



LUDLOW SOLID
IN IRISH OAK



HARLECH

The timeless appeal of the Harlech composite door makes this design a popular choice, particularly for properties with gable ends. The glazed inserts on these solid timber doors are available in a range of designs.



HARLECH 2
IN BLACK WITH
JEWEL GLASS

HARLECH 2
IN GREEN

HARLECH 2
IN BLUE WITH
CTB 8 2 GLASS



HARLECH 2 COMPOSITE DOOR IN BLUE

CONWAY

Whether your home is a period property or a modern one, the clean and simple lines of the Conway make it a perfect choice either way. It comes with a range of glazed panel options.



PRAIRIE



ABSTRACT



CONWAY 1
IN ANTHRACITE GREY
WITH CSB 5 1FT GLASS

CONWAY 3
IN BLACK WITH
ROYALE GLASS

CONWAY SOLID
IN IRISH OAK



CONWAY 3 COMPOSITE DOOR IN
BLACK WITH DIAMOND BLACK GLASS



TENBY 4 IN OAK WITH SEPARATE TOP LIGHT



FLINT 3 WITH STAR BLACK GLASS ANTHRACITE GREY

TENBY

Modern, yet also timeless, the Tenby is a quietly understated modern classic. There's also a great selection of glazed panel designs to make your Tenby door uniquely yours.



CALEDONIAN ROSE



SIMPLICITY



TENBY 4

IN BLUE WITH CTL 36.4 GLASS

TENBY 4

IN ANTHRACITE GREY WITH QUAD BLACK GLASS

TENBY SOLID

IN IRISH OAK



FLINT

With country cottages and farmhouses in mind, the Flint composite door offers a distinctive traditional look, available with single or triple square apertures or a single rectangular glazing. You can specify this with a vertical panel style, and also as a solid door with no glazing. This design works really well as a stable door.



FLINT 1

IN CHARTWELL GREEN WITH BULLS EYE GLASS

FLINT 2

IN WHITE WITH CTB8 GLASS

FLINT 3

IN DUCK EGG BLUE WITH QUAD BLUE GLASS

FLINT 4

IN WHITE WITH ROYALE GLASS

FLINT 5

IN WHITE WITH WAIKATO GLASS

FLINT SOLID

IN IRISH OAK



WINDSOR SOLID IN FRENCH GREY

WINDSOR

Looking for something a bit more modern? Then the Windsor makes a striking statement with its rectangular panelling, and is also available with a large glazed insert.



WINDSOR
IN FRENCH GREY

WINDSOR
IN CHARTWELL GREEN

WINDSOR
IN IRISH OAK



WINDSOR COMPOSITE DOOR
WITH GLAZING CASSETTE

NOTTINGHAM

Doors in the unique Nottingham range are ideal for traditional properties as they feature arched glazed panels with a choice of designs.



NOTTINGHAM 2
IN BLACK WITH
OYALE GLASS

NOTTINGHAM 2
IN GREEN WITH
CTL 3.2 GLASS

NOTTINGHAM 2
IN ROSEWOOD WITH
JEWEL GLASS



THORNBURY

The Thornbury composite door adds an elegant yet subtle finish to any entrance.



THORNBURY
IN DUCK EGG BLUE

THORNBURY
IN CREAM

THORNBURY
IN CHARTWELL GREEN

THORNBURY
IN IRISH OAK

"A highly professional company.

We were recommended by friends who couldn't speak highly enough of the service and workmanship carried out. I have to say my experience has been exactly the same, a professional local company that takes pride in delivering a first class service.

Their whole approach from start to finish was exemplary, from the initial technical explanation, offer, expert fit and job completion, all works carried out with great assurance. We have had 28 windows and more replaced and can't thank Richard, Raymond, Simon and Lewis with enough praise for a job expertly well done."



CLEAR GLASS LUDLOW FRENCH DOORS IN ROSEWOOD



FLINT 2 IN CHARTWELL GREEN WITH CLEAR GLASS

SIDE PANELS & TOP LIGHTS

Enhance your new or replacement composite door with either a fully integrated matching full or half height composite side light. Available either solid or with glass, and in a range of colours, inside or out.

We can also manufacture, supply and install top lights to match your chosen composite door design.

All side and top lights are fully welded and reinforced, and feature the same 48mm thick solid timber core, durable plastic edge banding and 2 plastic thermo skins for security and strength. They're also fitted with energy-efficient Pilkington KS glass.

- 1 Harlech CTB Side Panel
- 2 Brescia Side Panel
- 3 Ludlow Abstract Side Panel
- 4 Tenby Side Panel
- 5 Nottingham Side Panel
- 6 Milano Side Panel
- 7 Infil Quarter Panel
- 8 Double Infil Half Panel





SCHWARZBRAUN PARMA FRENCH DOORS 1800MM LONG BAR HANDLES AND CLEAR GLASS



BEESTON FLINT STABLE DOOR IN IRISH OAK



COMPOSITE FRENCH DOORS

Our French doors are available in all our composite door styles. Fantastique!

Previously we could only offer these in uPVC, but now you can get the French door look with all the strength, durability and good looks of a composite construction, and with the same choice of beautiful colours, inside and out. You can also specify them for either inward or outward opening movement.



STABLE DOORS

For kitchen or back doors, a composite stable door brings a whole new dimension to this part of your home. Enjoy all the benefits of a uPVC door but with none of the maintenance hassle of a traditional timber stable door.

Whether you want inward or outward opening, our composite stable doors are available in any of our colours, both inside and out, and the majority of our styles - excluding some Italia designs - ask for details.

We can also manufacture composite stable doors to any size, such as the one on the right which measures just 1740mm x 940mm.

Complete the farmhouse look with our extensive range of traditional and contemporary ironmongery, including door knockers, door handles and letter plates. Our Accessories pages show the full range.





BESPOKE SHAPED FLINT COMPOSITE DOOR IN ROSEWOOD WITH WHITE FRAME AND SIDE LIGHTS

BESPOKE SHAPED COMPOSITE DOOR IN BLACK WITH WHITE FRAME

SHAPED COMPOSITE DOORS

Doors for homes with non standard entrances

Traditionally, homes with unique door frames have not been able to specify a composite door frame. But after research and investment, coupled with our industry experience, we are able to offer a truly bespoke design and installation service. The perfect choice when you want the benefits of a composite door that sits in harmony with the character of your home.

Available opening inwards or outwards.



BESPOKE SHAPED COMPOSITE DOOR IN RUBY RED WITH ELEGANCE GLASS



ITALIA PISA COMPOSITE DOOR IN PEACOCK BLUE WITH TOP AND SIDE LIGHTS IN SINGLE FRAME



BESPOKE FRENCH WINDSOR STYLE COMPOSITE DOOR IN GOLDEN OAK WITH 800MM HANDLES

"Great service, from the initial showroom meeting and detailed presentation to the installation - excellent experience all round. Really happy with the finished product and the guys who installed. Would definitely recommend..."



PREMILINE PATIO

For that understated architectural look the Premiline Patio range of sliding doors from Kommerling are available with 2, 3 or 4 panel openings. Subtle, understated but also incredibly strong, these doors also feature high security locking mechanisms operated through a patented interlock shootbolt system.

Premiline Patio meets the requirements of Lifetime Homes standard, developed as a quality benchmark by the Joseph Rowntree Foundation. Our close working partnership with Kommerling means that all these products will be designed to meet your exact specifications, from initial technical measurements to our final expert installation.

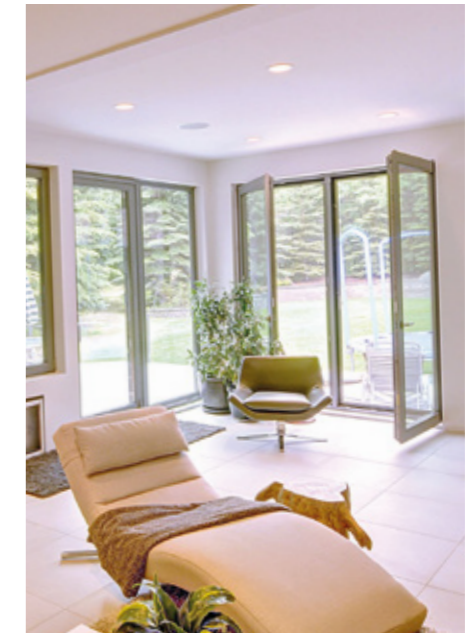

IMAGE COURTESY OF KOMMERLING

BI-FOLD & SLIDING DOORS

Bring the outside in with bi-fold or sliding doors, and create an inviting space for those spring, summer and autumn months when you just want to make the most of the sun.

Choose from 2, 3 or 4 pane door systems which can span up to 6 metres - ideal for large openings such as open plan kitchen/dining areas.

Aluminium

We can manufacture slimline aluminium bi-fold and sliding doors to replace entire walls to expand your living area and create a sense of open space. By reducing the sight lines, we can optimise the amount of natural daylight that floods into the room.

We fit Pilkington KS Glass as standard to all our bi-fold and sliding doors which, thanks to its low emissivity, achieves high energy ratings. (See our Energy pages for more information).

This advanced technology glass reflects heat back into the room whilst also letting heat in from the sun. We can also fit integrated blinds into your bi-fold doors as the picture above.



uPVC TILT & SLIDE PATIO

As an alternative to a bi-fold door, Kommerling's tilt and slide door is a great solution, giving you the option to both slide the doors open or tilt if you just want to allow a light breeze into your home.

These patio doors come with an internal handle as standard, with the option for an external handle to be added.





FLUSH SASH WINDOWS

The windows and doors industry continues to thrive on innovation, and the very latest development is flush sash windows from Kommerling, also known as flush casement windows.

The reason why this innovative new window design is so popular is that it has such a clean, minimalist look. Already very common in Scandinavia, flush sash windows are characterised by sashes that finish flush with the external face of the window.

Thanks to decades of research and development and comprehensive expertise from Kommerling, the external flush contours you see on flush sash windows can now be designed to mimic the look of traditional casement windows made of timber. You can now benefit from high performance uPVC window design packed with heritage features, but with none of the high maintenance that comes with traditional timber.

One of the key advantages of both our 070 and C70 flush sash windows is they can reach an impressive U value of 1, which meets the new building regulations introduced in June 2022 to address higher standards of thermal efficiency.

Under these new regulations, all new replacement windows and doors must achieve a thermal efficiency U rating of 1 W/m² or less. If you're looking for architectural harmony, or just a clean, minimalist look, flush sash (or flush casement) windows are the way to go.



uPVC WINDOWS, DOORS & CONSERVATORIES

Apart from aluminium frames and composite doors, we also offer a comprehensive range of uPVC windows, doors and conservatories. Whatever the style or finish, all our products are available in a choice of foil-laminated colours. Durable, hard-wearing and weather resistant. Dual and additional colours are available on request.



We offer a standard colour and eight premium colours.

COLOURS AVAILABLE

STANDARD



WHITE

**Please note that the following swatches are for illustrative purposes only and may vary from their appearance in person.*

PREMIUM

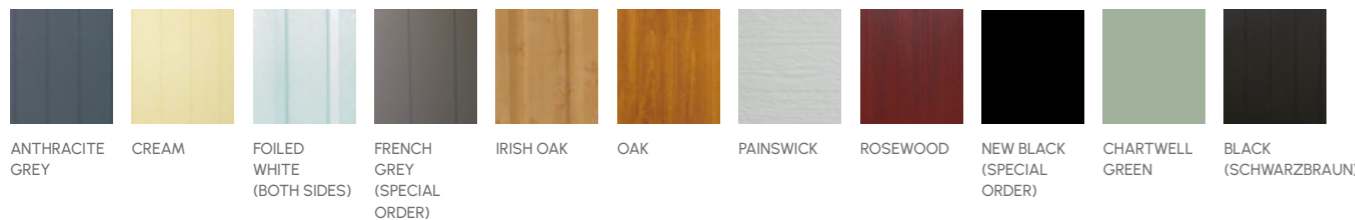

COLOURS AVAILABLE

The following colours and woodgrains form part of our 2021-2022 range and benefit from an upgraded surface. For other options please speak to your local Kömmerling partner.

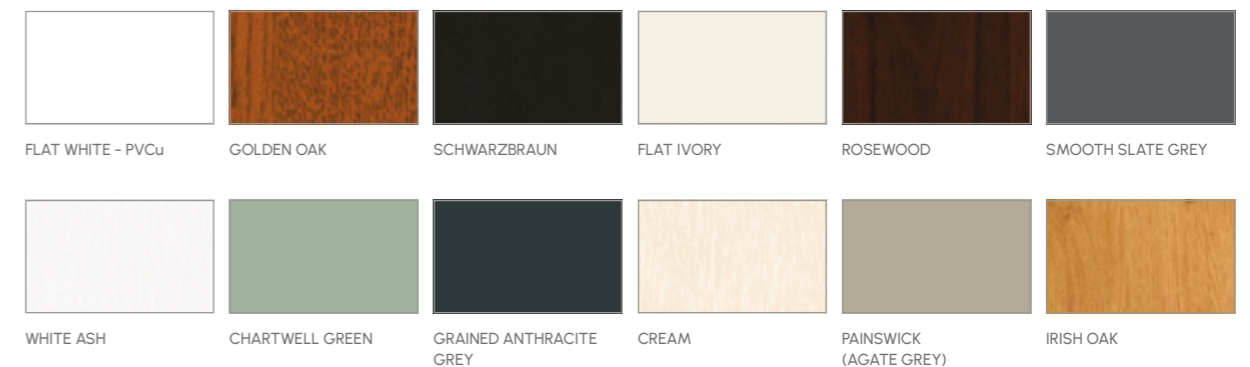



uPVC WINDOWS

We manufacture an extensive range of window styles, including:

- Patio (with tilt and slide option)
- Casement sash (with sash horns)
- Tilt and turn (with concealed window hinges)

Our coloured window frames are also available with coloured interior trims to complement the frames. They're also manufactured with internal beading as standard.

We can also supply and install roofline fascias, soffit boards and cladding to match.

Head over to our website to find out more.



uPVC DOORS & STABLE DOORS

In addition to our range of uPVC windows, we manufacture a wide selection of uPVC door styles including residential front doors, French doors, patio doors, and stable doors. All of these are fully reinforced with galvanised steel.

All our uPVC residential doors are fitted with state-of-the-art locking mechanisms and handles, as standard, including shot bolts and hooks to top and bottom, dead bolts and four rollers for compression.

Security cylinders are fitted to all doors as standard.





CREAM uPVC FRENCH DOORS WITH SIDE PANELS AND CAT FLAP



WHITE PVC CONSERVATORY WITH SELF-CLEANING ROOF



uPVC FRENCH DOORS

Bring the outside in with this stylish addition to your home, available in a choice of colours (inside and out), with the peace of mind that comes from knowing they're safe and secure too.

Offering unrestricted views to your patio, garden or conservatory, our range of uPVC French doors are internally beaded and have a multi point locking system as standard.

Energy efficient and high quality, you can have them opening inwards or outwards, and choose from our accessory range if you want non-standard handles (additional cost may apply).



ANTHRACITE GREY ON IRISH OAK PVCU FRENCH DOORS



BESPOKE SHAPED PVCU FRENCH DOORS IN IRISH OAK

uPVC CONSERVATORIES

A Victorian invention, but now a stylish addition to modern, contemporary homes, a uPVC conservatory creates an extra room that brings light and warmth to your home during spring, summer and autumn.

Glass and polycarbonate are the two main materials used for conservatory roofs, which come in a range of different colours and various heat guarding foils to regulate heat.

Our vast experience of designing and installing conservatories means you can be assured of the highest quality standards, with each one made to your own style preferences and specifications. And as project managers we oversee the whole process to make it as stress-free as possible for you.



WHITE CONSERVATORY WITH SUNBURST DESIGN AND POLYCARBONATE ROOF



Flush Sash



KOMMERLING

We believe the Kommerling 070 Gold and C70 uPVC systems are the best products available on the market, which is why we only manufacture our windows and doors using these systems. It means you're investing in premium quality products that will last the test of time and stay looking good.

070 Gold:

- 5-chambered with revolutionary ovolo or rounded profiles, providing a unique combination of classic appearance and state-of-the-art performance
- Curved slimline frame and opening sash create a 'softer' appearance while offering unrivalled benefits
- Steel reinforced profiles
- High security multi-point locking and shoot bolts
- Extruded using a lead-free uPVC Greenline compound
- Fitted with Pilkington KS glass
- Meet or exceed Level C on Energy Rating Certificate in accordance with latest Building Regulations

C70:

- This is also a 5 chamber system but its chamfered finish creates a more modern look and feel but without compromising thermal efficiency or security.

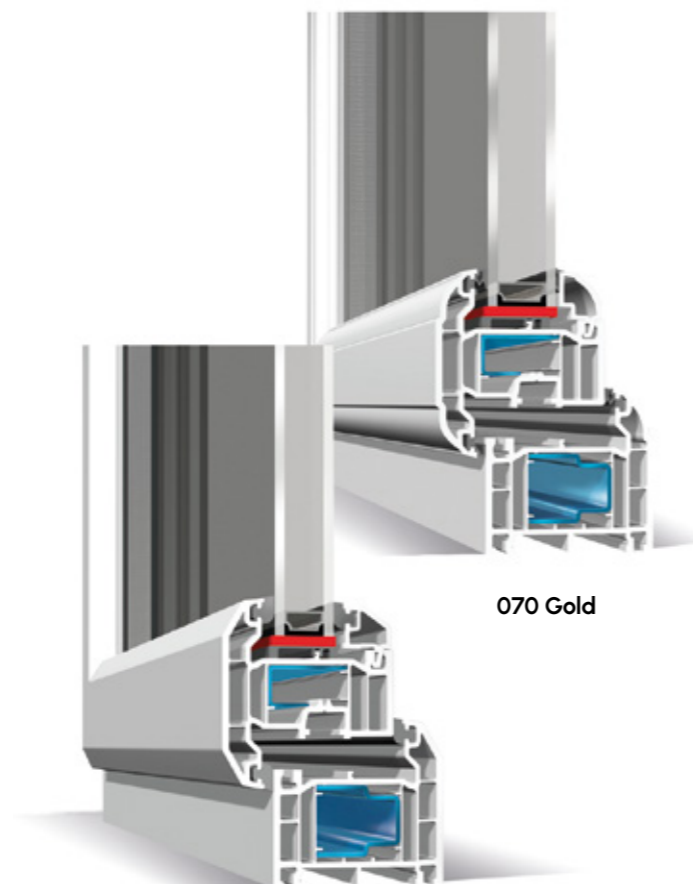

C70



PILKINGTON KS GLASS

The smart glass technology that helps save and generate heat from the sun

Since 2002, we started using Pilkington's K glass as standard, and from 2010 we moved on to its more advanced KS glass which offers high levels of energy efficiency and lower emissivity. Low emissivity coated glass reflects heat back into the room, whilst also letting in free heat from the sun - this is known as passive solar gain. Pilkington KS Glass helps windows and doors achieve high energy ratings in order to comply with Building Regulations Part 1.

All windows and doors are fitted with high quality handles, and high security, state-of-the-art locking mechanisms.

Upgrades on ironmongery are available to suit your individual taste. See p51-52 for details.



"Having had all our windows and doors of our bungalow replaced by Lockwood Windows, we have no hesitation in recommending this company.

The recommendation starts from Richard coming to give us an estimate and advising us of things we hadn't thought of and things we didn't need, Raymond in the showroom advising us of the finer details of the items, through to the fitters, Matthew and Luke who were polite, courteous, jovial and friendly and cleaned up continuously.

The quality of the windows and doors is excellent and has made such a difference to the appearance of our bungalow."



ENERGY & SECURITY FOR YOUR WINDOWS

You insist on the best, and so do we.

Now, more than ever, we value the energy we use to heat our homes. And windows and doors can play a really big part in making our homes as energy efficient as possible.

The British Fenestration Rating Council (BFRC), in conjunction with the UK glazing industry has designed a window rating system which provides simple and accurate information regarding the energy efficiency of each product.

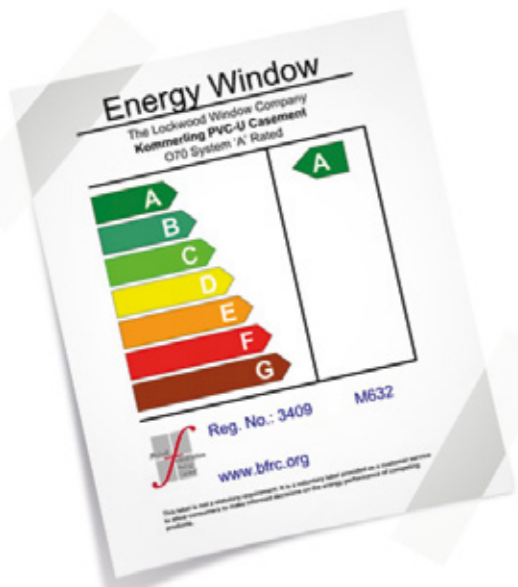

Make the right choice, with the right information

The BFRC provides third party certification for the total performance of windows, which are rated using the familiar A to G scale on the basis of their total energy efficiency, with A being the highest rating and G the lowest.

As a consumer, this makes it easy to understand the performance of each window product, and also for government inspectors to quickly see if a window meets the legal requirements.

Don't fall into the trap of making a decision based on a false economy. In order to achieve a C rated window or above, some companies choose to use a basic uPVC system which achieves the required efficiency rating. However, the downside is that all-important security is compromised by the use of a thermal plastic sleeve for reinforcement, or no reinforcement at all.

Before deciding on which company to use for your new or replacement doors and windows, take a look at our checklist.

For your complete peace of mind, all windows supplied and/or installed by Lockwood Windows are A-rated as standard.

1 Is your supplier part of the BFRC authorised retailer scheme or a member of FENSA? This provides you of assurances of their professionalism and standards.

2 Does the supplier use the A-E energy-efficiency rating? This will help you make a more informed choice as to which windows you choose.

3 Do the frames of your new windows have integral metal reinforcement to maximise security? Window frames without this will not be as secure.

4 Is your supplier listed in the Master Window and Conservatory Installers Association's Top 100 list?

At Lockwood Windows we are not prepared to compromise on security or quality, and have invested heavily to provide the most energy efficient and secure window systems available on the market today.





ACCESSORIES

The finishing touches to create that brilliant first impression on your door.

It's the tiny details that make all the difference, which is why we offer a wide range of handles, knockers, letter plates and numbers for both composite and uPVC doors, windows and conservatories.

Traditional or contemporary, our range of styles and finishes will help you create the look you want to achieve.

- P47 Door knockers
- P48 Door knockers
- P49 Door handles
- P50 Door guards, thumb turns, window handles
- P51 Door numbers, hinges and letter plates
- P52 Escutcheons, Door pulls

- 1 Victorian Urn - Hardex - Bronze
- 2 Horsetail Knocker - Chrome
- 3 Door Hinge (PVC Only)
- 4 Letterplate - Hardex - Gold



DOOR KNOCKERS

- 5 Victorian Urn - HG
- 6 Victorian Urn - SI
- 7 Victorian Urn - SAT
- 8 Victorian Urn - HB
- 9 Victorian Urn - GR
- 10 Victorian Urn - HS
- 11 Victorian Urn - WH
- 12 Victorian Urn - HC
- 13 Victorian Urn - BL
- 14 Victorian Urn - AV
- 15 Victorian Urn Spyhole - HG
- 16 Victorian Urn Spyhole - SAT
- 17 Victorian Urn Spyhole - HB
- 18 Victorian Urn Spyhole - SI
- 19 Victorian Urn Spyhole - HS
- 20 Victorian Urn Spyhole - WH
- 21 Victorian Urn Spyhole - HC
- 22 Victorian Urn Spyhole - BL
- 23 Victorian Urn Spyhole - AV

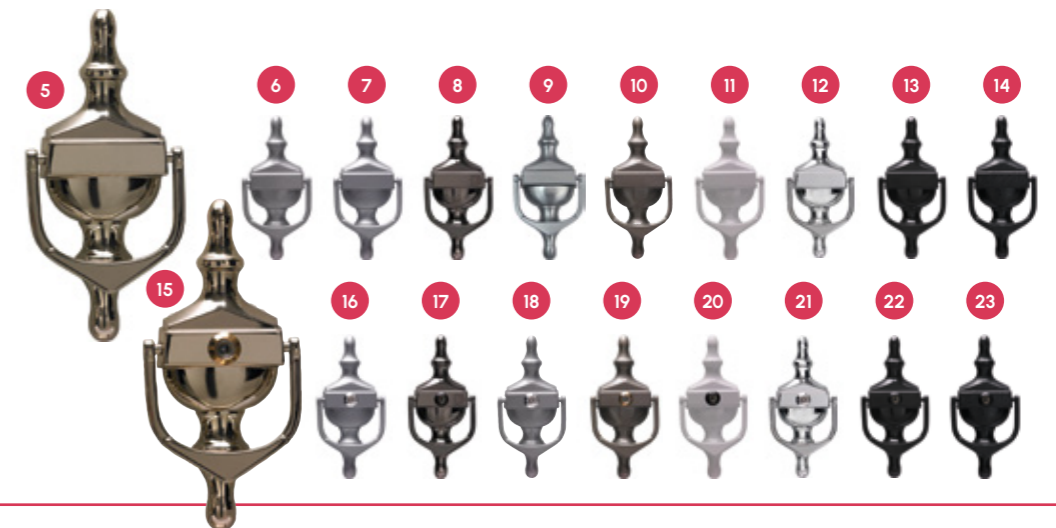

- 24 Slim Knocker - HB
- 25 Slim Knocker - WH
- 26 Slim Knocker - SI
- 27 Slim Knocker - SAT
- 28 Slim Knocker - HS
- 29 Slim Knocker - HG
- 30 Slim Knocker - HC
- 31 Slim Knocker - AV
- 32 Slim Knocker - BL
- 33 Slim Knocker Spyhole - HB
- 34 Slim Knocker Spyhole - WH
- 35 Slim Knocker Spyhole - SI
- 36 Slim Knocker Spyhole - SAT
- 37 Slim Knocker Spyhole - HS
- 38 Slim Knocker Spyhole - HG
- 39 Slim Knocker Spyhole - HC
- 40 Slim Knocker Spyhole - AV
- 41 Slim Knocker Spyhole - BL





DOOR HANDLES

DOOR KNOCKERS



- 42 Lions Head Knocker - HS
- 43 Lions Head Knocker - HC
- 44 Lions Head Knocker - HB
- 45 Lions Head Knocker - AB
- 46 Lions Head Knocker - WH
- 47 Lions Head Knocker - SAT
- 48 Lions Head Knocker - HG
- 49 Lions Head Knocker - BL
- 50 Horsetail Knocker - HS
- 51 Horsetail Knocker - AV
- 52 Horsetail Knocker - WH
- 53 Horsetail Knocker - SI
- 54 Horsetail Knocker - HC
- 55 Horsetail Knocker - HB
- 56 Horsetail Knocker - BL
- 57 Horsetail Knocker - AB
- 58 Horsetail Knocker - HG
- 59 Contemporary Knocker - HG
- 60 Contemporary Knocker - WH
- 61 Contemporary Knocker - HC
- 62 Hand Made Pewter Ring
- 63 Hand Made Black Ring
- 64 Slimline Art Deco Knocker - BL
- 65 Loop Door Knocker - Polished Brass
- 66 Shropshire Door Knocker - Pewter
- 67 Regency Door Knocker - Pewter
- 68 Ring Door Knocker - Pewter
- 69 4" Ring Door Knocker - BL



- 70 ES24 Pull Handle
- 71 EK53 Pull Handle
- 72 EK350 Pull Handle
- 73 Mushroom Know Door Handle
- 74 Inline Handle - 80
- 75 Inline Handle - 100
- 76 Inline Handle - 120
- 77 Inline Handle - 140
- 78 Inline Handle - 160
- 79 Inline Handle - 180
- 80 D Handle
- 81 Lever Handle - HS
- 82 Lever Handle - HG
- 83 Lever Handle - HC
- 84 Lever Handle - BL
- 85 Lever Handle - AB
- 86 Lever Handle - WH
- 87 Lever Handle - SI
- 88 Lever Handle - HB
- 89 Windsor Handle - WH
- 90 Windsor Handle - SI
- 91 Windsor Handle - HC
- 92 Windsor Handle - HB
- 93 Windsor Handle - AB
- 94 Windsor Handle - HS
- 95 Windsor Handle - HG
- 96 Windsor Handle - BL
- 97 Reeded Slimline Sprung Level Espag - Aged Brass
- 98 Newbury Level Handle Slimline - Aged Brass
- 99 Avon Slimline Sprung Level Espag - BL
- 100 Cottage Slimline Sprung Level Espag - Pewter
- 101 Art Deco Centre Door Knob - BL
- 102 Prestbury Centre Door Knob - Aged Brass



THUMB TURNS / WINDOW HANDLES

- 103 Thumb Turn Cylinder and Heritage Lock
- 104 Teardrop Handle - Chrome
- 105 Monkey Tail Handle - AB
Also available in:
Black
Chrome
Gold
Graphite
- 106 Inline Handle - WH
- 107 Inline Handle - BL
- 108 Inline Handle - HB
- 109 Inline Handle - SI
- 110 Inline Handle - HC
- 111 Inline Handle - AB
- 112 Inline Handle - HG
- 113 Inline Handle - HS
- 114 Door Stop
- 115 Floor Mounted Doorstop - BL
- 116 Peardrop Espagnolette Left/Right Hand Small - BL



DOOR NUMBERS, HINGES & LETTERPLATES

- 117 Numail Letterplate - GR
- 118 Numail Letterplate - AB
- 119 Numail Letterplate - BL
- 120 Numail Letterplate - WH
- 121 Numail Letterplate - SI
- 122 Numail Letterplate - SS
- 123 Numail Letterplate - HS
- 124 Numail Letterplate - SAT
- 125 Numail Letterplate - HG
- 126 Numail Letterplate - HC
- 127 Numail Letterplate - HB
- 128 Traditional Letterbox - Black
- 129 Number - S
- 130 Number - WH
- 131 Number - HG
- 132 Numerals - Polished Brass
- 133 Door Hinge - HS - PVC Only
- 134 Door Hinge - HC - PVC Only
- 135 Door Hinge - SAT - PVC Only





FINDING US

ESCUTCHEONS

- 136 Avon Euro - In Pewter
- 137 Regency Euro - In Pewter



DOOR PULLS

- 138 Euro Door Pull - In Black
- 139 Euro Door Pull - In Aged Bronze



The Lockwood Window Co. Ltd
 Unit 4 - Perserverance Mills, Lockwood Scar,
 Huddersfield, West Yorkshire HD4 6BW

T: 01484 519677 F: 01484 519676
 E: info@lockwoodwindows.co.uk
 W: lockwoodwindows.co.uk



Composite Doors Yorkshire

Composite Doors Yorkshire
 Unit 4 - Perserverance Mills, Lockwood Scar,
 Huddersfield, West Yorkshire HD4 6BW

T: 01484 544571 F: 01484 519676
 E: info@lockwoodwindows.co.uk
 W: compositedoorsyorkshire.co.uk



The Lockwood Window Co. Ltd
Unit 4 - Perserverance Mills, Lockwood Scar,
Huddersfield, West Yorkshire HD4 6BW

01484 519677

lockwoodwindows.co.uk